

**INSTALLATION  
INSTRUCTIONS  
for  
SLO-SYN<sup>®</sup>  
MODEL SS2000MD4M-O  
MICROSTEP  
DRIVE/OSCILLATOR**



## ENGINEERING CHANGES

Superior Electric reserves the right to make engineering refinements on all its products. Such refinements may affect information given in instructions, Therefore, USE ONLY THE INSTRUCTIONS THAT ARE PACKED WITH THE PRODUCT.

RECORD OF REVISION		
Revision	Date	Description
A	5/04/98	Initial Release
B	5/4/00	Revise corporate identity

# TABLE OF CONTENTS

<b><u>SECTION</u></b>	<b><u>Page</u></b>
<b>THINGS TO KNOW BEFORE USING THIS EQUIPMENT .....</b>	<b>3</b>
<b>WARRANTY INFORMATION.....</b>	<b>3</b>
<b>SECTION 1: INTRODUCTION .....</b>	<b>3</b>
1.1 Using This Manual .....	3
1.2 Product Features .....	4
<b>SECTION 2: EXPRESS START UP PROCEDURE .....</b>	<b>5</b>
<b>SECTION 3: INSTALLATION GUIDELINES .....</b>	<b>6</b>
3.1 Mounting .....	6
3.2 Terminal Locations And Assignments .....	7
3.2.1 Motor Connections .....	8
3.2.2 Power Input Connections .....	10
<b>SECTION 4: SPECIFICATIONS .....</b>	<b>11</b>
4.1 Mechanical Specifications .....	11
4.2 Electrical Specifications .....	11
4.3 Environmental Specifications .....	11
4.4 Motor Compatibility .....	11
4.5 Switches and Potentiometers .....	13
4.5.1 Motor Current Settings.....	13
4.5.2 Automatic Current Reduction.....	13
4.5.3 Run Speed Source.....	13
4.5.4 External Speed Input Scaling.....	13
4.5.5 Potentiometers .....	14
4.6 Signal Specifications .....	15
4.7 Timing Considerations .....	16
4.8 Indicator Lights .....	18
<b>SECTION 5: TORQUE VERSUS SPEED CHARACTERISTICS .....</b>	<b>18</b>
5.1 Motor Performance .....	18
5.2 Typical Torque Vs. Speed Curves .....	19
<b>SECTION 6: TROUBLESHOOTING .....</b>	<b>27</b>
<b>APPENDIX A: TROUBLESHOOTING ELECTRICAL INTERFERENCE PROBLEMS.....</b>	<b>29</b>

**FIGURE**

**Page**

3.1 Mounting Diagram..... 6

3.2 Terminal Locations ..... 7

3.3 Motor Wiring Configurations..... 9

3.4 Typical Power Supply for a Single Unit Application..... 10

4.1 Switch and Potentiometer Locations ..... 14

4.2 Suggested Methods for Control Interface..... 16

4.3 Timing Considerations ..... 17

Typical Torque Versus Speed Curves

    M061-LE08 Series and Parallel ..... 19

    M062-LE08 Series and Parallel, M063-LE08 Series ..... 20

    M063-LE08 Parallel, M091-FD8109 Series and Parallel..... 21

    M092-FD8109 Series and Parallel, KML060F08 ..... 22

    KML060F11, KML061F05, KML061F11 ..... 23

    KML062F07, KML062F13, KML063F07..... 24

    KML063F13, KML091F07, KML091F13..... 25

    KML092F07, KML092F13..... 26

## THINGS TO KNOW BEFORE USING THIS EQUIPMENT

- Only qualified personnel should install or perform servicing procedures on this equipment.
- Before performing any work on the unit, allow at least five minutes for the capacitors to discharge fully.
- Voltage is present on unprotected pins when the Drive/Oscillator is operational.
- Motors powered by the Drive/Oscillator may develop extremely high torque. Be sure to disconnect power to the unit before doing any mechanical work.

### CAUTION:

The SLO-SYN<sup>®</sup> SS2000MD4M-O is designed for 24 to 40 Vdc input only (see Section 4.2, Electrical Specifications, Page 11).

## WARRANTY INFORMATION

Reconfiguration of the circuit in any fashion not shown in this manual will void the Warranty.

Failure to follow the installation guidelines as described in Section 3 will void the Warranty.

## SECTION 1: INTRODUCTION

### 1.1 - USING THIS MANUAL

It is important that you understand how the SLO-SYN<sup>®</sup> SS2000MD4M-O Drive/Oscillator is installed and operated before you attempt to use it. **We strongly recommend that you read this manual completely before proceeding with the installation of this unit.**

This manual is an installation and operating guide to the SLO-SYN SS2000MD4M-O Drive/Oscillator. Section 1 gives an overview of its features. Section 2 describes the steps necessary to place the MD4M-O into operation. General wiring guidelines as well as the physical mounting of the unit and connections to the drive portion are covered in Section 3.

Complete specifications, listed in Section 4, provide easily referenced information concerning electrical, mechanical and environmental specifications. The procedure for setting the motor current level and connection of Oscillator I/O are also covered in this section.

Torque versus speed characteristics with all appropriate SLO-SYN Stepper Motors are given in Section 5. Section 6, Troubleshooting, gives procedures to follow if the Drive/Oscillator fails to operate properly.

Appendix A provides procedures for troubleshooting electrical interference problems.

## **1.2 - PRODUCT FEATURES**

The SLO-SYN SS2000MD4M-O Drive/Oscillator combines a bipolar, two-phase PWM drive which uses hybrid power devices and a control/oscillator in one compact package. Micro-stepping at 1/32 step resolution (6400 pulses/revolution) is used to ensure smooth low speed operation. The maximum running speed is 3,000 rpm. Features include:

- Switch selectable motor current levels of 1.0 through 3.5 amperes
- Microprocessor-based Digital Oscillator for accurate speed control
- Built-in Potentiometers for Accel, Decel, Low Speed, and Run Speed
- Full short circuit protection (phase-to-phase and phase-to-ground)
- Undervoltage and transient overvoltage protection
- Efficient thermal design
- Windings Off capability
- User selectable Automatic Current Reduction at standstill
- Compact size
- Sturdy all-aluminum mounting base
- Run Speed Control from Built-in Potentiometer or External Voltage Input

## SECTION 2: EXPRESS START UP PROCEDURE

The following instructions define the minimum steps necessary to make your Drive/Oscillator operational.

### CAUTION:

**Always disconnect the power to the MD4M-O before connecting or disconnecting the motor leads. FAILURE TO DO THIS WILL RESULT IN A SHOCK HAZARD AND MAY DAMAGE THE DRIVE.**

**Always operate the Drive/Oscillator with the Motor and unit enclosure GROUNDED. Be sure to twist together the wires for each motor phase as well as those for the dc input. Six twists per foot (0.3 m) is a good guide line.**

1. Check to see that the motor used is compatible with the Drive/Oscillator. Refer to Section 4.4 for a list of compatible motors.
2. Set the correct current level for the motor being used and set the switches per the instructions in Section 4.5.1. **Heat sinking may be required to maintain case temperature below +70 C (+158 F).**
3. Select the desired motor current at standstill (50% or 100%) and set switch #6 as described in section 4.5.2.
4. Select the appropriate run speed source (on board trim pot or external input) and set switch #7 as described in Section 4.5.3. If an external run speed voltage source is to be used select the appropriate voltage range (0-5V or 0-10V) and set switch #8 as described in Section 4.5.4.
5. Wire the motor per the "Motor Connections" description in Section 3.2.
6. Connect the power source to the DC input terminal strip. Be sure to follow the instructions for connecting the filter capacitor as described in Section 3.2, under Power Input.
7. Set the desired Accel rate, Decel rate, Low speed, and motor running speed using the appropriate potentiometers as described in Section 4.5.5.

NOTES: If the motor operates erratically, refer to Section 5, "Torque Versus Speed Characteristics".

Clockwise and counterclockwise directions are properly oriented when viewing the motor from the end opposite the mounting flange.

## SECTION 3: INSTALLATION GUIDELINES

### 3.1 - MOUNTING

The MD4M-O is mounted by fastening its mounting brackets to a flat surface. Dimensions are shown in Figure 3.1. If the Drive/Oscillator assembly is mounted against a bulkhead, be sure to apply a thin coating of thermal compound (such as Dow Corning type 340 Silicone Heatsink Compound) between the Drive/Oscillator and the mounting surface before fastening the unit in place. Do not use too much thermal compound. It is better to use too little than too much.

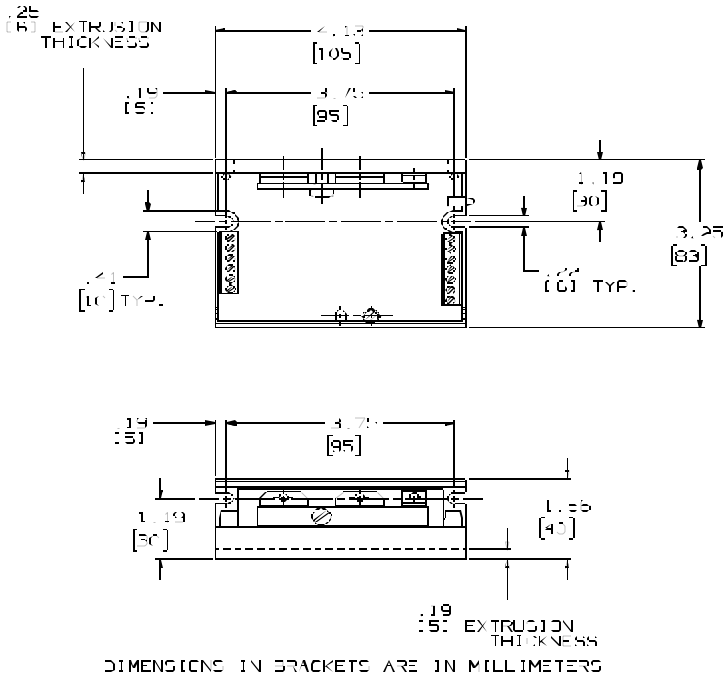

Figure 3.1, Mounting Diagram

NOTE: Case temperature must not exceed +70° C (+158° F).

When selecting a mounting location, it is important to leave at least two inches (51mm) of space around the top, bottom and sides of the unit to allow proper airflow for cooling.

It is also important to keep the MD4M-O away from obvious electrical noise sources. If possible, locate the unit in its own metal enclosure to shield it and its wiring from electrical noise sources. If this cannot be done, keep the unit at least three feet (0.9 m) from any noise sources.





### 3.2.1 - MOTOR CONNECTIONS

All motor connections are made via the 6-pin terminal strip. Terminal assignments are given below. Motor connections are shown in Figure 3.3.

<b>J2 Pin</b>	<b>Assignment</b>
1	M1 (Phase A+)
2	M3 (Phase A-)
3	M4 (Phase B+)
4	M5 (Phase B-)

**NOTE: Motor phase A is M1 and M3 and motor phase B is M4 and M5.  
The motor frame must be grounded.**

Cabling from the Drive/Oscillator to the motor should be done with a shielded, twisted-pair cable. The wires for each motor phase should be twisted together about six times per foot (0.3 m).

Superior Electric offers the following motor cable configurations. These cables have unterminated leads on both ends.

<b>Length</b>	<b>Part Number</b>
10 ft (3 m)	216022-031
25 ft (7.6 m)	216022-032
50 ft (15.2 m)	216022-033
75 ft (22.8 m)	216022-034

Figure 3.3 shows the possible motor wiring configurations.

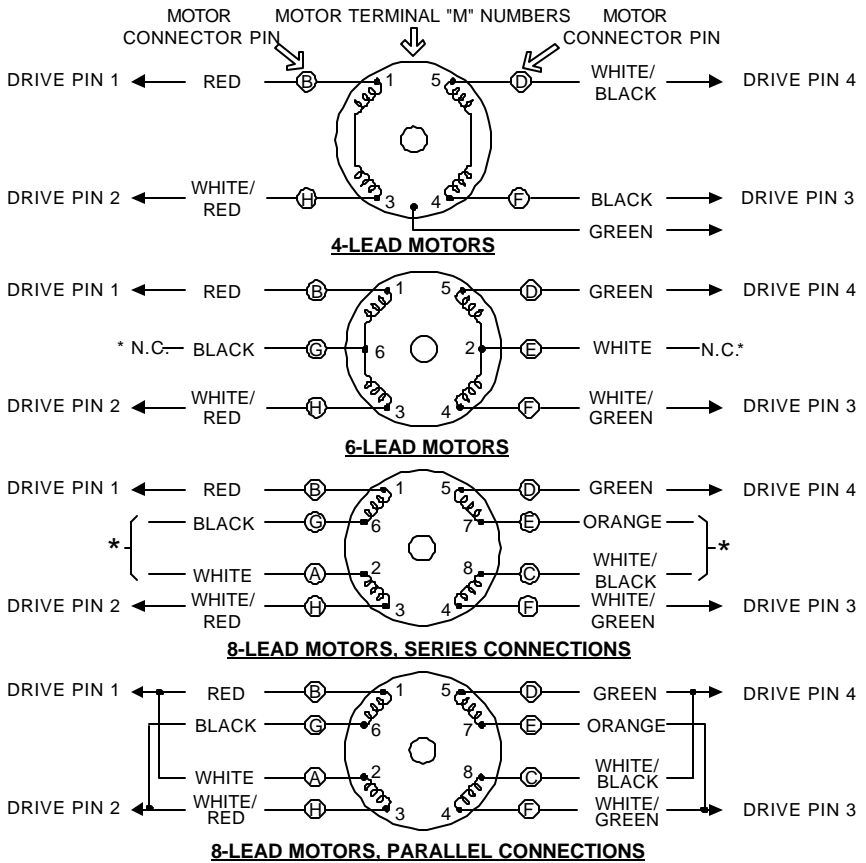

**\*These leads must be insulated and isolated from other leads or ground.**

Circled letters identify terminals for connector motors, numbers identify those for terminal box motors.

**Figure 3.3, Motor Wiring Configurations**

### 3.2.2 - POWER INPUT CONNECTIONS

The dc input power is connected to terminals 5 and 6 of the 6-pin terminal strip (J2). Terminal 5 [Vm(+)] is the power supply plus (+) connection and pin 6 [Vom (-)] is the power supply minus (-) connection.

**An unregulated supply similar to that shown in Figure 3.4 is preferable. If a regulated supply is used, it must be capable of operating with the added filter capacitor. A switching regulated supply may not be suitable for use with this product. It is important that the capacitor (C1) be connected within three feet (0.9 meter) of the input terminals. The capacitor must be of the correct value and have the proper current and voltage parameters (see list of components below).**

It is recommended that the power supply leads be twisted together using approximately six twists per foot (0.3 m).

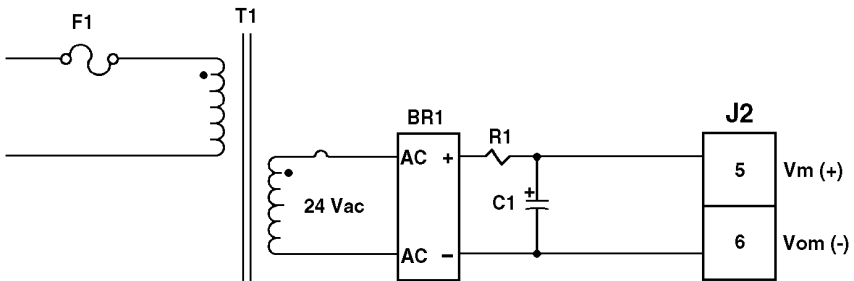

NOTES: (1) The cable between the filter capacitor (C1) and the MD4M-O Drive/Oscillator should be twisted using approximately six twists per foot (0.3 m). Maximum wire length is three feet.

(2) Use #16 AWG or larger wire.

(3) If the power supply is grounded, it must only be grounded on the negative side or the short circuit protection will not operate properly.

**Figure 3.4**  
**Typical Power Supply For A Single Unit Application**

#### Components for circuit shown in Figure 3.4

F1 1.5 ampere time delay, 250 volt

R1 5 ohm surge limiter, Dale 7SS5 or equivalent

T1 130 VA, 24 Vac output

BR1 General Instrument GBPC3502 or equivalent

C1 4700  $\mu\text{f}$ , 5.5 ampere 20 kHz, 63 V rated, United Chemcon  
53D472F063HS6 or equivalent

## SECTION 4: SPECIFICATIONS

### 4.1 MECHANICAL SPECIFICATIONS

Size  
(Inches)..... 1.56 H x 4.13 W x 3.25 D  
(mm)..... 40 H x 105 W x 83 D  
Weight..... 10.3 ounces (292 grams)

### 4.2 ELECTRICAL SPECIFICATIONS

DC Input Range..... 24 Vdc min., 40 Vdc max.  
DC Current..... see Motor Table  
Drive/Oscillator Power Dissipation  
(Worst Case)..... 35 watts

### 4.3 ENVIRONMENTAL SPECIFICATIONS

Temperature  
Operating..... +32 °F to +122 °F  
(0° C to +50° C) free air ambient, Natural Convection.  
Maximum heat sink temperature of 158 °F (70 °C) must  
be maintained. Forced-air cooling may be required.  
Storage ..... -40° F to +167° F  
(-40° C to +75° C)  
Humidity ..... 95% max. noncondensing  
Altitude ..... 10,000 feet (3048 m) max.

### 4.4 MOTOR COMPATIBILITY

Motor Types ..... Superior Slo-Syn M and KM Series  
M Series Frame Sizes ..... M061 (NEMA 23D) through M092 (NEMA 34)  
KM series frame sizes ..... KML060 (NEMA 23) through  
KML092 (NEMA 34)  
Number of Connections .... 4, 6, 8  
Minimum Inductance..... 0.5 millihenry  
Maximum Resistance..... = 0.25 x Vdc Supply/I Setting  
Example:  
Vdc = 30 I Setting = 3.5  
R max. = 0.25 x 30/3.5 = 2.1 ohms

**NOTE:**.....Maximum resistance is total of motor plus cable.

**CAUTION:** Do not use larger frame size motor than those listed, or the Drive/Oscillator may be damaged. If a larger frame size motor must be used, consult the factory for recommendations.

## MOTORS FOR USE WITH THE SS2000MD4M-O DRIVE/OSCILLATOR

Motor	Winding	Connection	Current Setting (Amperes)	Power Supply Current	
				Standstill (Amps. DC)	Maximum (Amps. DC)
M061	08	Series	2.5	1.0	2.0
M061	08	Parallel	3.5	1.0	2.0
M062	09	Series	3.0	1.0	2.5
M062	09	Parallel	3.5	1.0	3.5
M063	09	Series	3.0	1.5	2.0
M063	09	Parallel	3.5	1.0	3.5
M091	09	Series	3.0	1.0	1.5
M091	09	Parallel	3.5	1.5	3.0
M092	09	Series	3.0	1.5	2.0
M092	09	Parallel	3.5	1.0	3.0
KML060F08	-	-	3.5	1.0	2.0
KML060F11	-	-	3.5	1.0	2.0
KML061F05	-	-	2.5	1.2	1.5
KML061F11	-	-	3.5	1.0	3.0
KML062F07	-	-	3.0	1.0	2.5
KML062F13	-	-	3.5	1.0	4.0
KML063F07	-	-	3.0	1.5	2.0
KML063F13	-	-	3.5	1.0	4.0
KML091F07	-	-	3.0	1.0	2.0
KML091F13	-	-	3.5	1.0	4.0
KML092F07	-	-	3.0	1.5	2.5
KML092F13	-	-	3.5	1.0	4.0

Power supply currents shown are measured at the output of the rectifier bridge in Figure 3.4.

M061, M062 and M063 motors listed include LS, LE, CS, FC and FD versions. M091 and M092 motors include FC and FD versions with 6 or 8 leads. Motors with windings other than those listed can be used as long as the current ratings listed on the motors are not exceeded.

All KML motors listed have 4 leads.

## 4.5 SWITCHES AND POTENTIOMETERS

### 4.5.1 Current Settings

The proper current setting for each motor is shown on the individual torque vs. speed curves. Use this current level to obtain the torque shown. Switches 1 through 5 are used to select the current level. Select the desired operating current by setting the appropriate switch to position 1 (ON). The OFF position is labeled "0". Only one switch should be ON. If two or more switches are ON, the one which selects the highest current level will be the active switch. The switch designations are as follows:

Switch	Current (amperes)
None (All OFF)	1.0
1	1.5
2	2.0
3	2.5
4	3.0
5	3.5

### 4.5.2 Automatic Current Reduce Disable

When switch #6 is in the OFF position, the current at standstill goes to 50% of the selected level. When switch #6 is in the ON position, the current at standstill remains at full value.

### 4.5.3 Run Speed Source

When switch #7 is in the OFF position the on board speed potentiometer is used as the run speed source. When switch #7 is in the ON position an external voltage applied to input "Vin" is used as the run speed source. Section 4.5.4 provides information on the scaling of this input.

### 4.5.4 External Speed Input Scaling

The external speed input (Vin) scaling is selected using switch #8. Placing switch #8 in the OFF position selects 0-5V as the range of the external speed input. The ON position sets the input range to 0-10V.

## 4.5.5 Potentiometers

On board potentiometers are provided for setting the following motion parameters: Accel, Decel, Low Speed, and Run Speed. Run Speed can also be set via:

- a) external potentiometer, see Section 4.5.3.
- b) external voltage input 0-5V or 0-10V, see Section 4.5.4.

This product is implemented using digital techniques. Micro-stepping at 1/32 step resolution (6400 pulses/revolution) is used to ensure smooth operation at low speeds. The settings for Accel, Decel, Low Speed and Speed are analog by nature and are converted to digital form using an 8-bit A/D. This will result in granularity in the resolution settings. The ranges of each parameter are specified in Full Steps/sec. and Full steps/sec<sup>2</sup>

Parameter	Description	Range	Resolution (8 bits)
Accel	Rate at which motor speed increases	4000 - 120,000	500 Full steps/sec <sup>2</sup> .
Decel	Rate at which motor speed decreases	4000 - 120,000	500 Full steps/sec <sup>2</sup> .
Low Speed	Motor starting speed	0 - 1200	40 Full steps/sec.
Speed	Motor running speed	0 - 10,000	40 Full steps/sec.

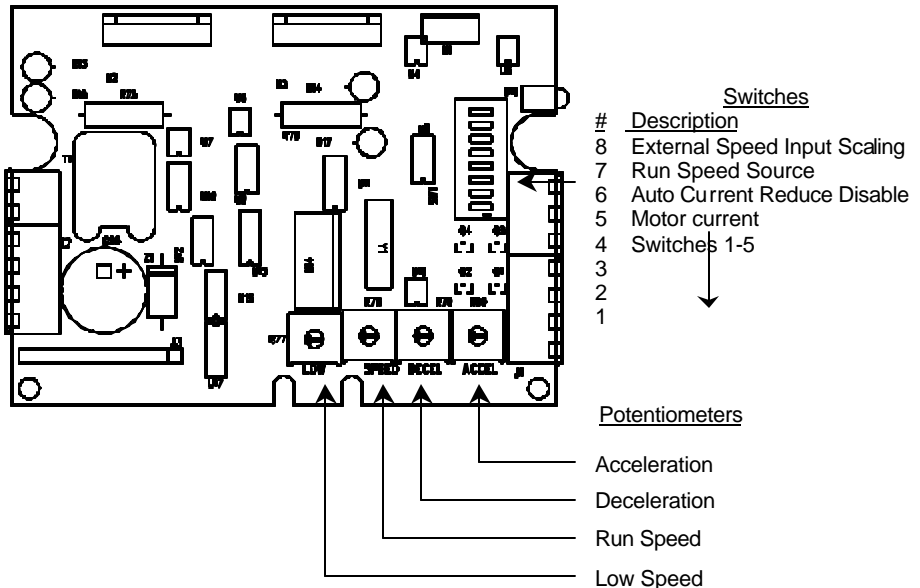

**Figure 4.1, Switch and Potentiometer Locations**



## 4.6 SIGNAL SPECIFICATIONS

### 4.6.1 I/O Terminal Assignments

All connections are made via the 7-pin terminal strip.

<u>J1 Pin</u>	<u>Assignment</u>
1	LOW SPEED
2	DIR
3	RUN
4	AWO
5	GND
6	EXT SPEED
7	+5V

### 4.6.2 Signal Descriptions

LOW SPEED	<b>Low Speed Input (J1-1)</b> When this input is activated (tied to GND) the Run Speed is set by the Low Speed potentiometer.
DIR	<b>Direction Input (J1-2)</b> When this signal is high, motor rotation will be clockwise. Rotation will be counterclockwise when this signal is low.
RUN	<b>Run Input (J1-3)</b> When this signal is low the motor will run in the direction set by the DIR input at the desired set speed.
AWO	<b>All Windings Off Input (J1-4)</b> When this signal is low, AC and DC current to the motor will be zero. <b>Caution: There will be no holding torque when the AWO signal is low.</b>
GND	<b>Signal ground (J1-5)</b> This ground point can be used for activating the discrete input signals on pins J1-1 through J1-4 . It can also be used as a reference point for an external voltage input or in conjunction with the +5V output (J1-7) to power an external speed potentiometer.
EXT SPEED	<b>External Run Speed Input (J1-6)</b> This is an optional input which can be used in place of the on board Run Speed potentiometer. Input range can be either 0-5V or 0-10V as defined by switch #8 described in Section 4.5.4.
+5V	<b>+5V output (J1-7)</b> This output is provided for powering an external speed potentiometer. Pin J1-5 is used as the ground reference.

### 4.6.3 Level Requirements

External Speed input (EXT SPEED)

Voltage ..... 0 to 10 VDC  
 Input Impedance..... 100K ohms

I/O Signals

Voltage  
 Low .....  $\leq 2.0$  and  $\geq 0.0$  VDC  
 High .....  $\geq 3.0$  VDC  
 Open Circuit Input Voltage .... 5 VDC typ.

Current  
 Logic 0 sink current .....  $\leq 1$  mA

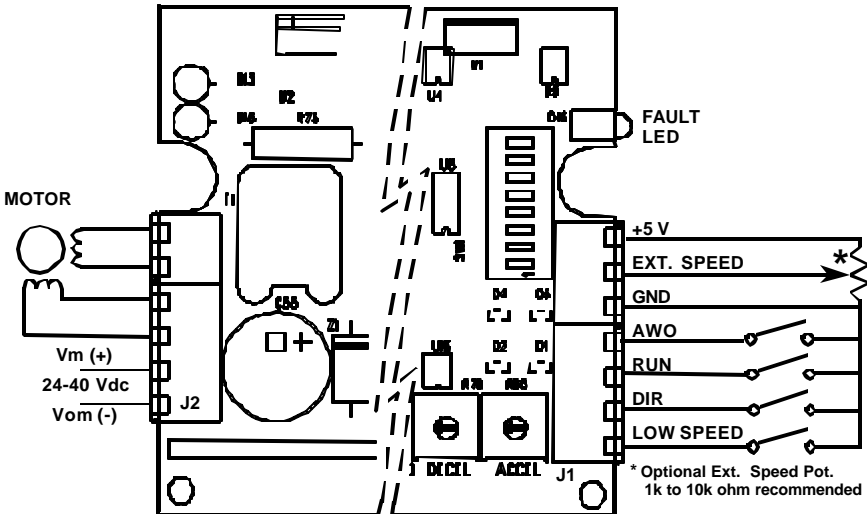

Suggested Methods For Control Interface

Figure 4.2

### 4.7 TIMING CONSIDERATIONS

NOTE: Refer to Figure 4.3.

When the RUN input is activated the motor goes from 0 speed to Low speed either immediately or after a 50 ms delay. If the LOW SPEED input is active the motor speed will stay at Low speed, otherwise the speed is increased to the Run speed at the acceleration rate set via the ACCEL potentiometer. When the RUN input is removed, the motor speed is decreased to Low Speed at the deceleration rate set via the DECEL potentiometer. Upon reaching Low Speed, the motor is stopped.

If selected, Auto Reduce Current takes effect 50 ms after the motor stops. The DIR input, which determines the motor rotation direction, is sampled when the RUN input goes active (Low/tied to GND).

All of the switch settings, potentiometer settings, and input signals can be changed "On-the-Fly" with the new settings, except DIR, effective immediately.

The following diagrams depict the timing relationships between the RUN input, motor speed, and motor current.

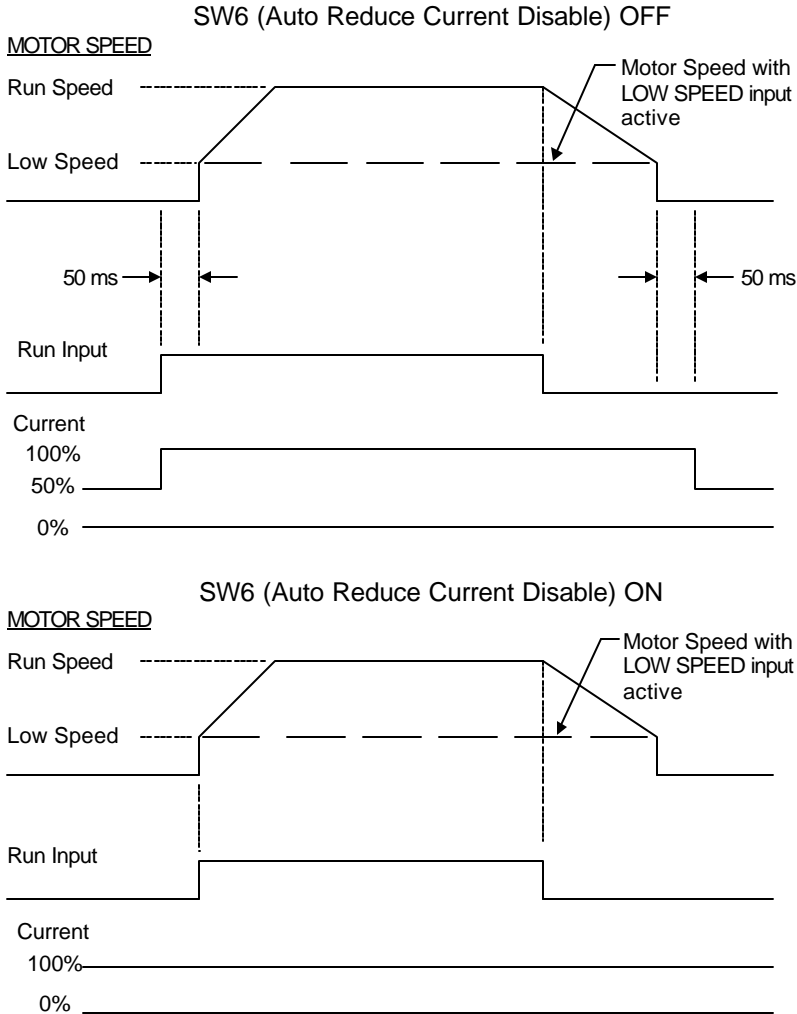

**Figure 4.3, Timing Considerations**

## 4.8 INDICATOR LIGHTS

"FAULT" LED, Red

Lights to indicate over current condition. This condition is caused by motor wiring errors or a ground fault.

Recovery from an over current condition requires removing and then reapplying the power.

# SECTION 5: TORQUE VERSUS SPEED CHARACTERISTICS

## 5.1 MOTOR PERFORMANCE

All stepper motors exhibit instability at their natural frequency and harmonics of that frequency. Typically, this instability will occur at speeds between 50 and 1000 full steps per second and, depending on the dynamic motor load parameters, can cause excessive velocity modulation or improper positioning. This type of instability is represented by the open area at the low end of each Torque vs. Speed curve.

There are also other instabilities which may cause a loss of torque at stepping rates outside the range of natural resonance frequencies. One such instability is broadly defined as mid-range instability. Usually, the damping of the system and acceleration/deceleration through the resonance areas aid in reducing instability to a level that provides smooth shaft velocity and accurate positioning. If instability does cause unacceptable performance under actual operating conditions, the following techniques can be used to reduce velocity modulation.

- 1) Avoid constant speed operation at the motor's unstable frequencies. Select a Low speed that is above the motor's resonant frequencies and adjust acceleration and deceleration to move the motor through unstable regions quickly.
- 2) The motor winding current can be reduced as described in Section 4.5. Lowering the current will reduce torque proportionally. The reduced energy delivered to the motor can decrease velocity modulation.

## 5.2 TYPICAL TORQUE VERSUS SPEED CURVES

NOTE: The test conditions used when obtaining the torque versus speed data are listed in the lower left-hand corner of each curve.

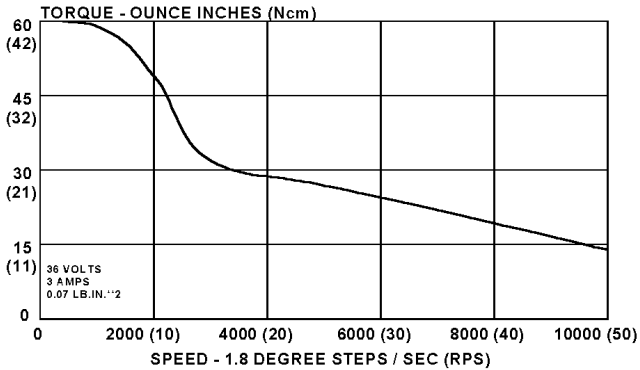

**M061-LE08, ETC., MOTORS, SERIES CONNECTED**

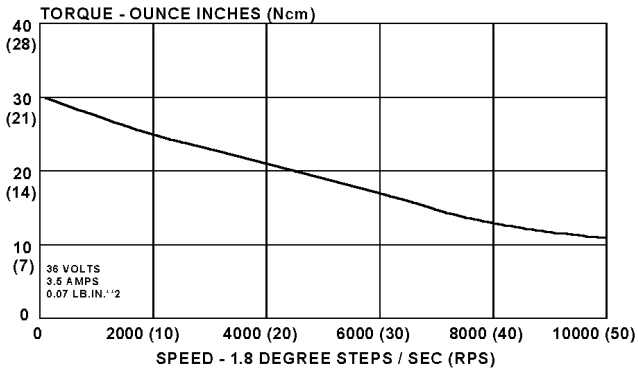

**M061-LE08, ETC., MOTORS, PARALLEL CONNECTED**

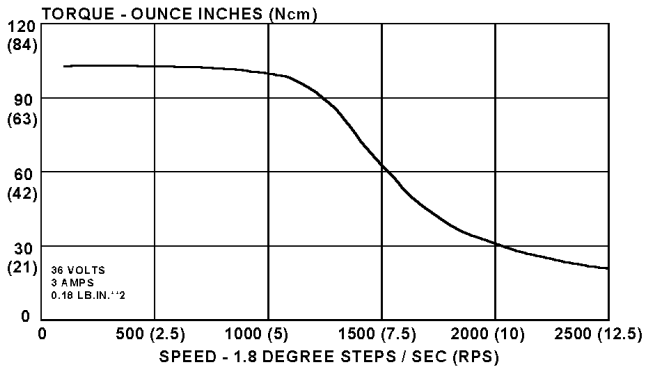

**M062-LE09, ETC., MOTORS, SERIES CONNECTED**

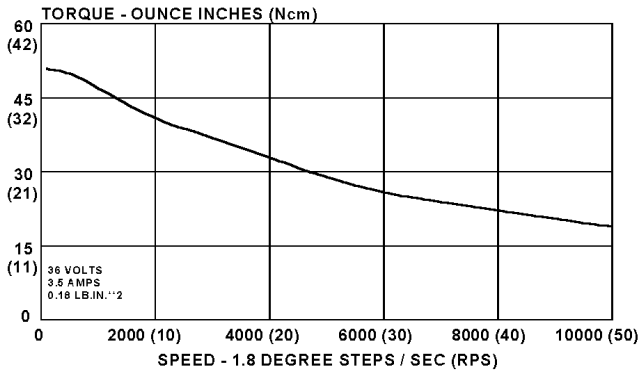

**M062-LE09, ETC., MOTORS, PARALLEL CONNECTED**

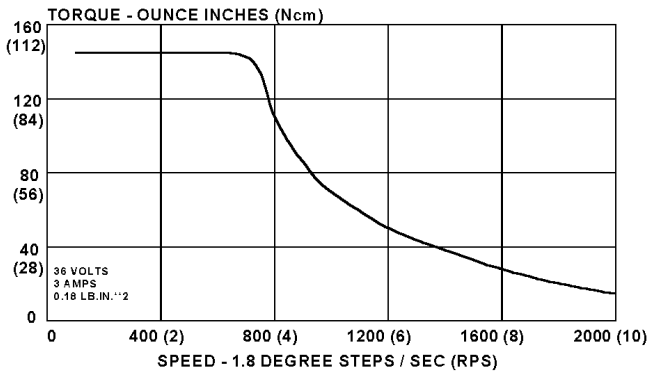

**M063-LE09, ETC., MOTORS, SERIES CONNECTED**

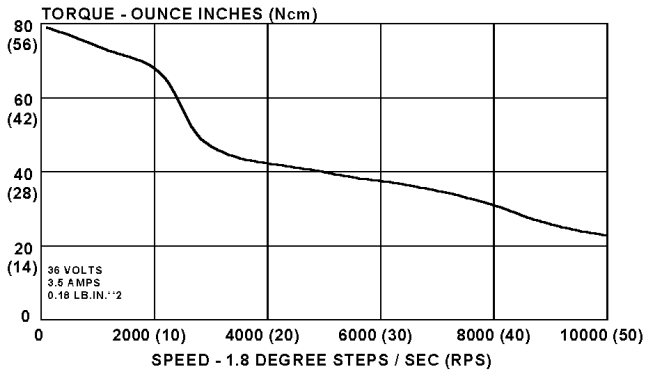

**M063-LE09, ETC., MOTORS, PARALLEL CONNECTED**

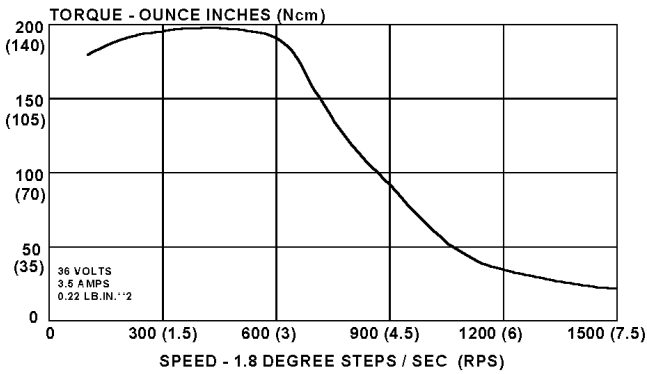

**M091-FD8109 MOTOR, SERIES CONNECTED**

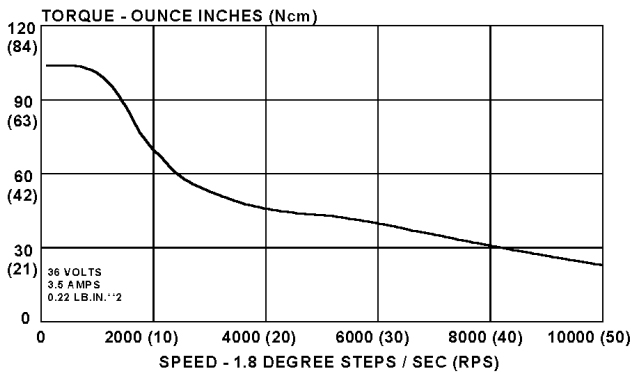

**M091-FD8109 MOTOR, PARALLEL CONNECTED**

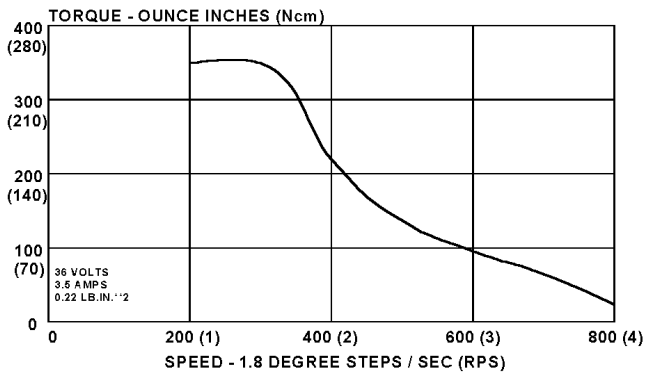

**M092-FD8109 MOTOR, SERIES CONNECTED**

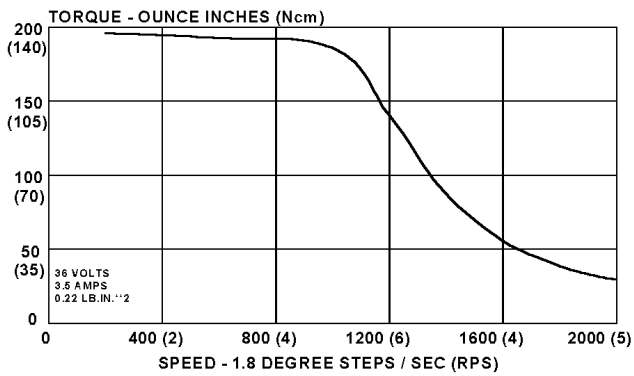

**M092-FD8109 MOTOR, PARALLEL CONNECTED**

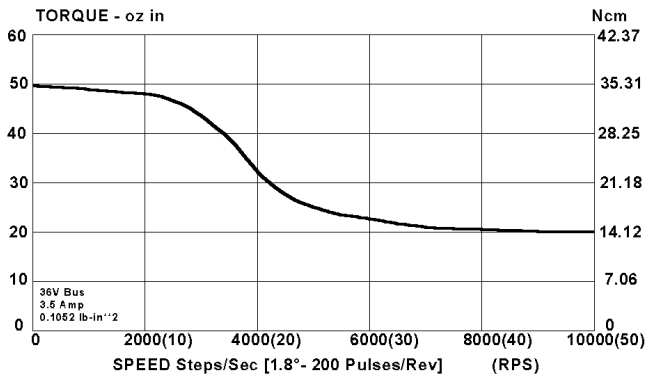

**KML060F08 MOTOR**



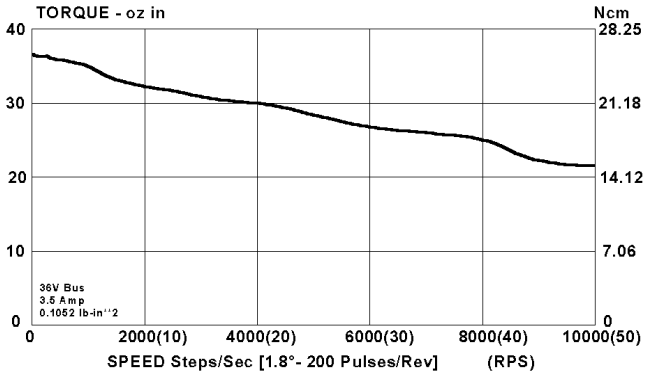

**KML060F11 MOTOR**

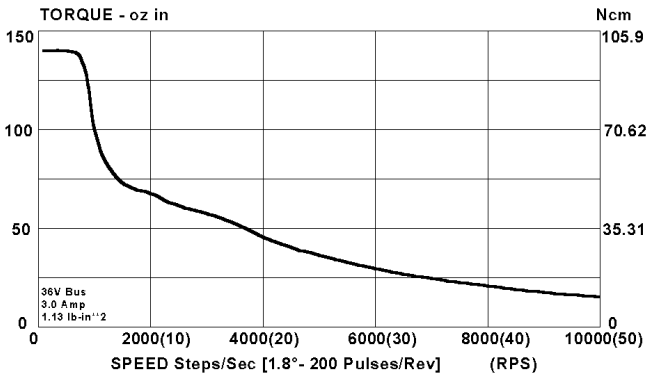

**KML061F05 MOTOR**

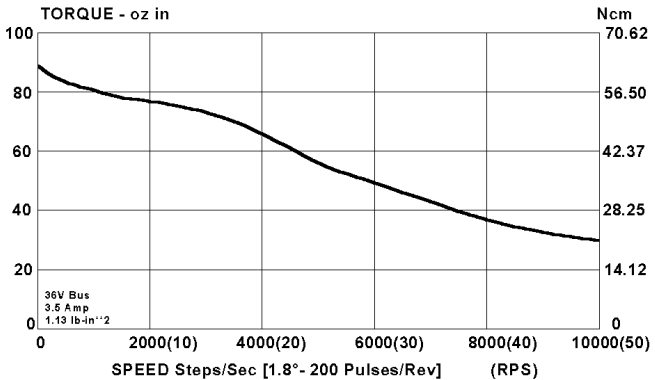

**KML061F11 MOTOR**

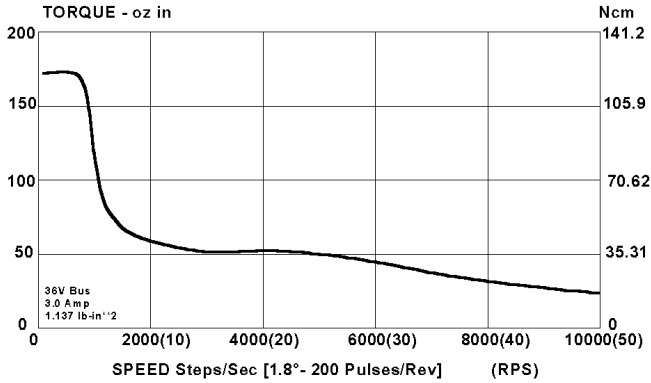

**KML062F07 MOTOR**

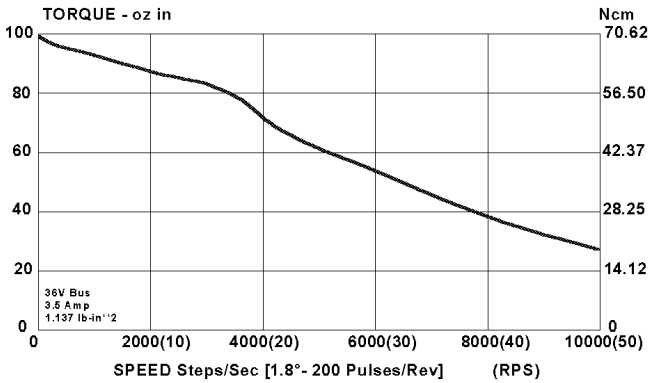

**KML062F13 MOTOR**

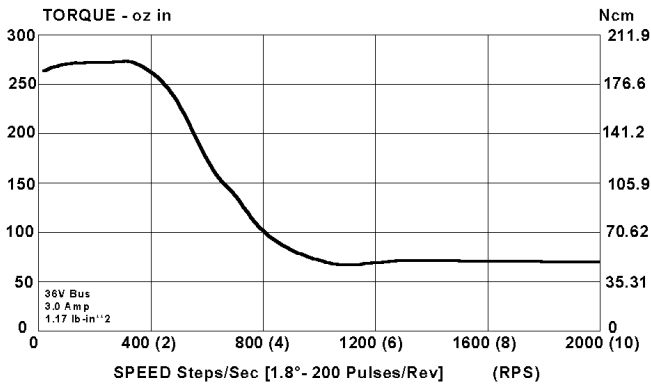

**KML063F07 MOTOR**

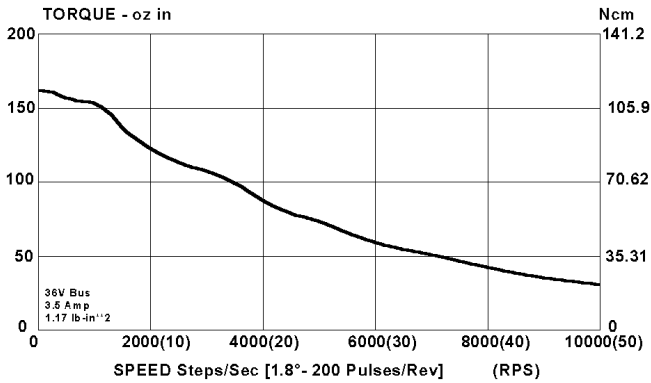

**KML063F13 MOTOR**

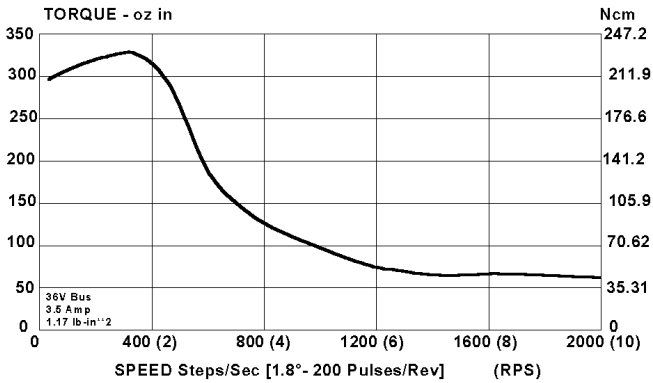

**KML091F07 MOTOR**

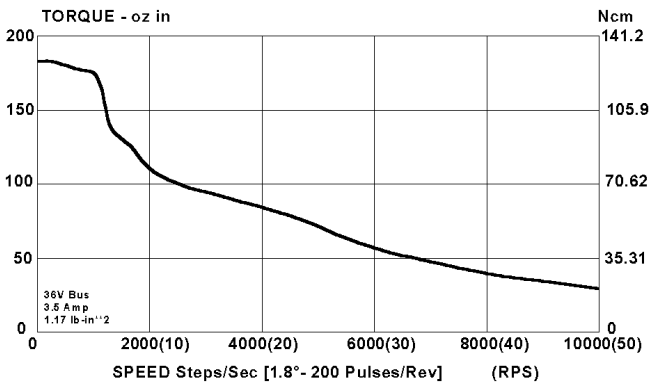

**KML091F13 MOTOR**

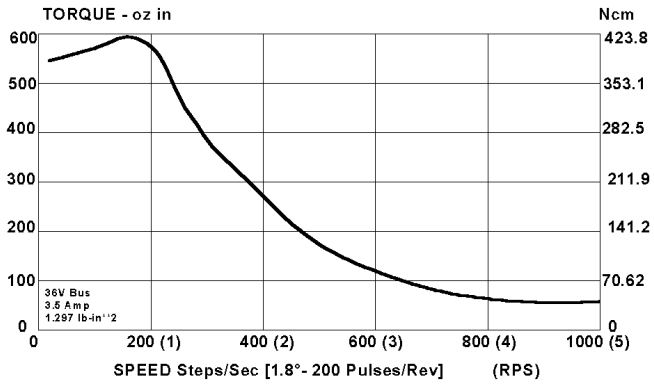

**KML092F07 MOTOR**

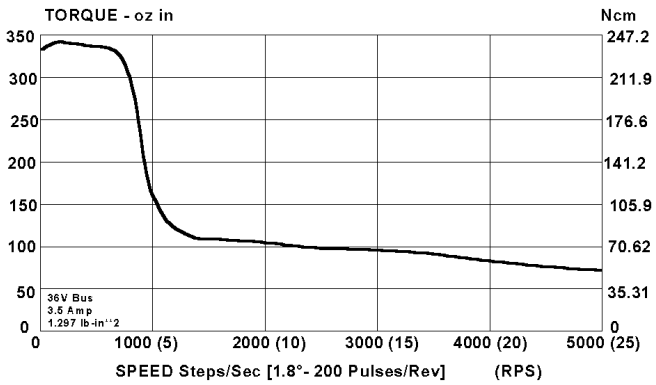

**KML092F13 MOTOR**

## SECTION 6: TROUBLESHOOTING

### **WARNING:**

**Motors connected to the MD4M-O can develop high torque and large amounts of mechanical energy.**

**Keep clear of the motor shaft and all parts mechanically linked to the motor shaft.**

**Turn off all power to the Drive/Oscillator before performing work on parts mechanically coupled to the motor.**

If installation and operating instructions have been followed carefully, this unit should operate correctly. If the motor fails to step properly, the following checklist will help in locating and correcting the problem.

### **In General:**

Check all installation wiring carefully for wiring errors or poor connections.

Check to see that the proper voltage levels are being supplied to the unit.

Be sure that the motor is a correct model for use with this unit.

### **Specifically:**

#### **IF MOTOR DIRECTION IS REVERSED, Check For:**

Reversed connections to the Motor Connector. Reversing the phase A or the phase B connections will reverse the direction of motor rotation.

#### **IF THE MOTOR MOTION IS ERRATIC, Check For:**

Supply voltage out of tolerance.

Improper motion parameters (low speed, acceleration, deceleration, low speed, and run speed).

Filter capacitor missing or too low in value.

**IF TORQUE IS LOW, Check For:**

All Windings Off active.

Correct current setting.

Improper supply voltage.

**IF "FAULT" INDICATOR IS LIT, Check For:**

Improper motor wiring

Grounded or shorted wiring to the motor or shorted motor

Improper motor type or incorrect Current Select switch setting

If a malfunction occurs that cannot be corrected by making the preceding checks, contact Superior Electric.

# **APPENDIX A: TROUBLESHOOTING ELECTRICAL INTERFERENCE PROBLEMS**

Electrical interference problems are common with today's computer - based controls, and such problems are often difficult to diagnose and cure. If such a problem occurs with your system, the following checks should be made to locate the cause of the problem.

1. Check the quality of the ac line voltage using an oscilloscope and a line monitor, such as the Superior Electric VMS series. If line voltage problems exist, use appropriate line conditioning, such as line filters or isolation transformers.
2. Be certain proper wiring practices are followed for location, grounding, wiring and relay suppression. It is highly suggested that twisted-pair cables be used for all signal inputs and motor wiring.
3. Double check the grounding connections to be sure they are good electrical connections and are as short and direct as possible.
4. Try operating the unit with all suspected noise sources switched off. If the unit functions properly, switch the noise sources on again, one at a time, and isolate which ones are causing the interference problems. When a noise source is located, try rerouting wiring, suppressing relays or other measures to eliminate the problem.

**Notes:**

---



## WARRANTY AND LIMITATION OF LIABILITY

Superior Electric (the "Company"), Bristol, Connecticut, warrants to the first end user purchaser (the "purchaser") of equipment manufactured by the Company that such equipment, if new, unused and in original unopened cartons at the time of purchase, will be free from defects in material and workmanship under normal use and service for a period of one year from date of shipment from the Company's factory or a warehouse of the Company in the event that the equipment is purchased from the Company or for a period of one year from the date of shipment from the business establishment of an authorized distributor of the Company in the event that the equipment is purchased from an authorized distributor.

**THE COMPANY'S OBLIGATION UNDER THIS WARRANTY SHALL BE STRICTLY AND EXCLUSIVELY LIMITED TO REPAIRING OR REPLACING, AT THE FACTORY OR A SERVICE CENTER OF THE COMPANY, ANY SUCH EQUIPMENT OR PARTS THEREOF WHICH AN AUTHORIZED REPRESENTATIVE OF THE COMPANY FINDS TO BE DEFECTIVE IN MATERIAL OR WORKMANSHIP UNDER NORMAL USE AND SERVICE WITHIN SUCH PERIOD OF ONE YEAR. THE COMPANY RESERVES THE RIGHT TO SATISFY SUCH OBLIGATION IN FULL BY REFUNDING THE FULL PURCHASE PRICE OF ANY SUCH DEFECTIVE EQUIPMENT.** This warranty does not apply to any equipment which has been tampered with or altered in any way, which has been improperly installed or which has been subject to misuse, neglect or accident.

**THE FOREGOING WARRANTY IS IN LIEU OF ANY OTHER WARRANTIES, EXPRESS OR IMPLIED, INCLUDING, WITHOUT LIMITATION, ANY IMPLIED WARRANTY OF MERCHANTABILITY OR FITNESS FOR A PARTICULAR PURPOSE,** and of any other obligations or liabilities on the part of the Company; and no person is authorized to assume for the Company any other liability with respect to equipment manufactured by the Company. The Company shall have no liability with respect to equipment not of its manufacture. **THE COMPANY SHALL HAVE NO LIABILITY WHATSOEVER IN ANY EVENT FOR PAYMENT OF ANY INCIDENTAL OR CONSEQUENTIAL DAMAGES, INCLUDING, WITHOUT LIMITATION, DAMAGES FOR INJURY TO ANY PERSON OR PROPERTY.**

Written authorization to return any equipment or parts thereof must be obtained from the Company. The Company shall not be responsible for any transportation charges.

**IF FOR ANY REASON ANY OF THE FOREGOING PROVISIONS SHALL BE INEFFECTIVE, THE COMPANY'S LIABILITY FOR DAMAGES ARISING OUT OF ITS MANUFACTURE OR SALE OF EQUIPMENT, OR USE THEREOF, WHETHER SUCH LIABILITY IS BASED ON WARRANTY, CONTRACT, NEGLIGENCE, STRICT LIABILITY IN TORT OR OTHERWISE, SHALL NOT IN ANY EVENT EXCEED THE FULL PURCHASE PRICE OF SUCH EQUIPMENT.**

Any action against the Company based upon any liability or obligation arising hereunder or under any law applicable to the sale of equipment, or the use thereof, must be commenced within one year after the cause of such action arises.

## **Distribution Coast-to-Coast and International**

Superior Electric products are available nationwide through an extensive authorized distributor network. These distributors offer literature, technical assistance and a wide range of models off the shelf for fastest possible delivery.

In addition, Superior Electric sales engineers are conveniently located to provide prompt attention to customers' needs. Call the nearest office listed for ordering and application information or for the address of the closest authorized distributor.

### **IN U.S.A. AND CANADA**

383 Middle Street  
Bristol, CT 06010

Tel: (860) 585-4500

FAX: 860-589-2136:

Customer Service: 1-800-787-3532

Product Application: 1-800-787-3532

Product Literature Request: 1-800-787-3532

Fax: 1-800-766-6366

Web Site: [www.Superiornet.com](http://www.Superiornet.com)

### **IN EUROPE**

Warner Electric (Int.) Inc.

La Pierreire

CH-1029 Villars-Ste-Croix, Switzerland

Tel: 41 021 631 33 55

Fax: 41 021 636 07 04

These products are sold subject to the standard Limitation of Liability and/or Warranty of Superior Electric.

The right to make engineering refinements on all products is reserved. Dimensions and other details are subject to change.